

***Bluetooth*[®] Enhanced Data Rate (EDR): The Wireless Evolution**

Application Note

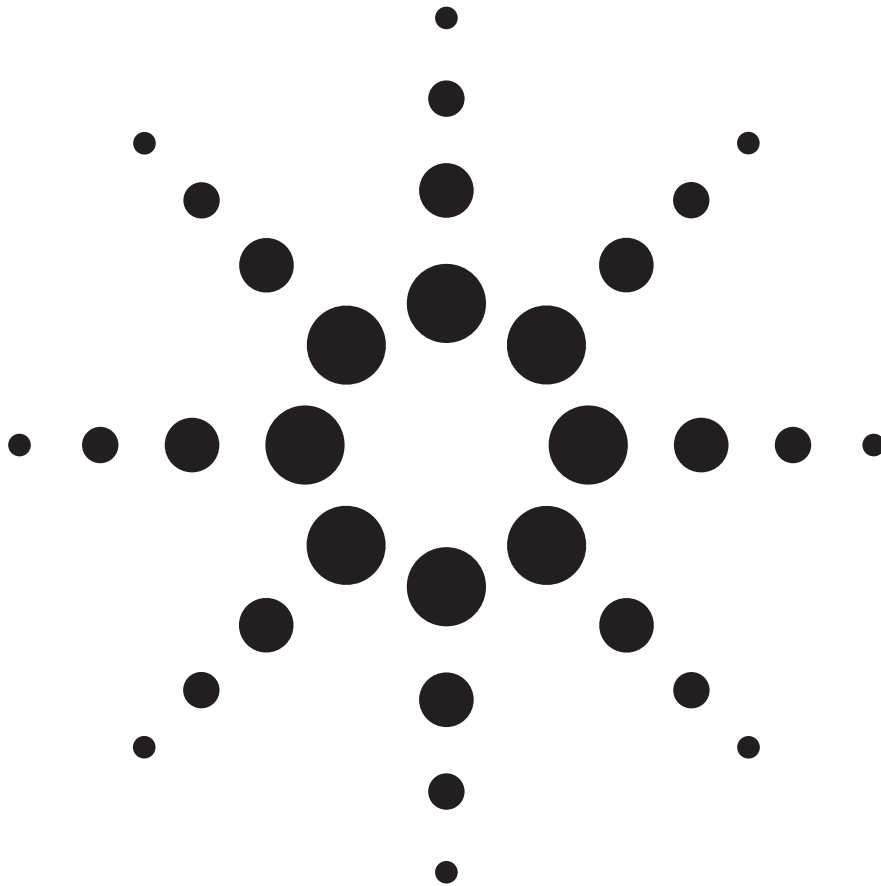

Agilent Technologies

Table of Contents

Introduction	1
A Brief Overview	4
<i>Bluetooth</i> [®] evolution from Version 1.0 to Version 1.2	6
<i>Bluetooth</i> evolution from Version 1.2 to Version 2.0+EDR	7
Market Drivers for <i>Bluetooth</i> EDR	8
Packet Structure and Modulation Format	9
Basic rate and EDR packet format	9
Basic rate and EDR modulation format	10
New Test Procedures and Test Cases for EDR	13
<i>Bluetooth</i> transmitter test cases for EDR	14
<i>Bluetooth</i> receiver test cases for EDR	19
Future Directions for <i>Bluetooth</i> EDR	21
Appendix A: Symbols and Acronyms	22
Appendix B: References	23

Introduction

Bluetooth[®] wireless technology is a short-range communication system intended to provide connectivity of voice and data between information appliances. Initially designed to operate with a peak data rate of 1 Mb/s, the *Bluetooth* core specification [1] has evolved to support 2 Mb/s and 3 Mb/s peak data rates with the introduction of the enhanced data rate (EDR) feature.

The *Bluetooth* Special Interest Group (SIG), chartered to advance and promote *Bluetooth* wireless technology, has defined a test specification [2] for conformance testing of the RF layer including the EDR mode. This application note is intended as a tutorial for the *Bluetooth* EDR operation and test. Included is a brief discussion of the market needs that drove the evolution of the core specification from v1.0 to v1.2 and continuing on to v2.0+EDR. An in-depth examination of the *Bluetooth* EDR standard will be provided which includes new test cases for provisional testing of transmitter and receiver designs.

A Brief Overview

Bluetooth systems operate in the unlicensed Industrial-Scientific-Medical (ISM) radio band at 2.4 GHz. Low-power RF transmission provides communication between devices over a range of 10 to 100 meters.

Bluetooth enables ad-hoc networking for up to eight devices without the need for a formal wireless infrastructure. To mitigate interference and fading, *Bluetooth* uses frequency hopping spread spectrum (FHSS) operation. FHSS also facilitates *Bluetooth* multiple access and coexistence among other types of wireless systems. The basic frequency-hopping pattern is a pseudo-random ordering of 79 channel frequencies in the ISM band. With the introduction of adaptive frequency hopping into the *Bluetooth* system, the performance can be greatly improved by eliminating channels with known interference. The hopping rate is nominally 1600 hops per second.

The *Bluetooth* system provides point-to-point connection or point-to-multipoint connections. Two or more devices sharing the same physical channel form an ad-hoc network or piconet. With one device acting as a master, up to seven other devices or slaves can be actively operating in the piconet. All devices in the piconet are synchronized to a common clock reference and frequency hop pattern, which is provided by the master. *Bluetooth* devices may operate in two or more overlapping piconets creating what is referred to as a scatternet. Figure 1 shows the network topology for a scatternet consisting of two separate piconets. In this figure, one device is acting as a master in one piconet and a slave in another. A single device may not operate as a master in more than one piconet as this would imply synchronization between the separate piconets. As specified, each piconet is required to operate independently using a distinct hop pattern and master clock.

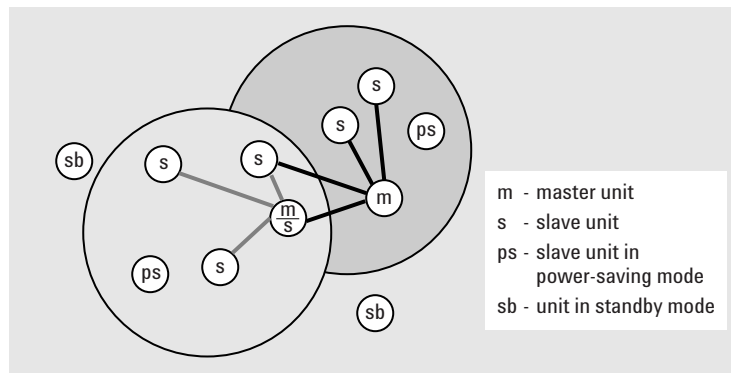

Figure 1. Scatternet topology formed by two piconets sharing common devices

The *Bluetooth* physical channel is sub-divided into time slots and transmission occurs using time division duplexing (TDD). The master transmits on even-numbered time slots and the slaves transmit on odd-numbered slots. The time slot length is a function of the frequency hop rate resulting in a nominal length of 625 μ s. Data is transmitted between the master and slaves in packets that are contained within the time slots. A device may use one, three, or five consecutive time slots for a single packet as coordinated by the master. The packet contains the access code, header, guard band, and payload. The payload contains the user data that is modulated onto the RF carrier using one of several different modulation schemes such as GFSK as specified in *Bluetooth* v1.0 and v1.2, and $\pi/4$ -DQPSK or 8DPSK introduced in v2.0+EDR of the core specification.

Within the *Bluetooth* channel, physical links are formed between the master and the slaves that are active in the *Bluetooth* piconet. There are two types of physical links, the synchronous connection-oriented (SCO) link primarily used for audio, and the asynchronous connectionless link (ACL) for data. The SCO and extended SCO (eSCO) link are point-to-point links between the master and the slave and may be considered as a circuit-switched connection. The ACL link provides a packet-switched connection between the master and all active slaves in the piconet. The master unit controls all traffic in the piconet, allocating capacity for the various SCO links and handling a polling scheme for ACL links.

The *Bluetooth* core system protocol consists of the radio (RF), link control (LC), link manager (LM) and logical link control and adaptation (L2CAP). The RF is layer 1 in the protocol stack.

***Bluetooth* evolution from Version 1.0 to Version 1.2**

One of the major and mandatory changes implemented in the *Bluetooth* core specification version 1.2 (v1.2) was the introduction of adaptive frequency hopping (AFH). One reason for the change was the result of coexistence problems occurring between *Bluetooth* and 802.11b/g WLAN. Both wireless systems share the same frequency range in the 2.4 GHz ISM band. The WLAN systems use direct sequence spread spectrum (DSSS) or OFDM technology with channel bandwidths up to 22 MHz. The *Bluetooth* systems use FHSS technology over 79 channels spaced 1 MHz apart. When both systems coexist, there is a 28 percent chance of collision between the two devices (22/79). Using AFH specified in v1.2, the *Bluetooth* system is capable of measuring interference, such as a WLAN signal, and avoiding those frequency channels with known interference. The system can adjust its number of usable channels down to 20 if necessary [3].

Another major and mandatory improvement implemented in v1.2 resulted in faster connection times. Originally connection times as high as four to five seconds were common using radios based on the original v1.0 specification. Changes made to the inquiry and paging operation in v1.2 that allowed connection times below 0.5 seconds. The faster connection times not only improved the user experience but also reduced manufacturing test time resulting in an overall lower product cost.

Other improvements implemented in v1.2 included enhanced functionality resulting in higher quality links and improved flow control. For example, v1.2 added the eSCO logical transport link. The eSCO is a SCO link with retransmission for the case when errors occurred in the data stream. The original *Bluetooth* core system for SCO supported synchronous data transmission at a constant rate using fixed-sized payloads at fixed time intervals. The eSCO link offers more flexible combinations of packet types and selectable data content in the packets and selectable slot periods, allowing a range of bit rates to be supported resulting in higher data transmission speeds. Originally 64 kb/s speech transmission was supported, but with changes in the v1.2 specification, several new packets were added that increase transmission rates up to 288 kb/s.

In all cases, the v1.2-compliant *Bluetooth* device must maintain backwards compatibility with the v1.0 specifications.

Bluetooth evolution from Version 1.2 to Version 2.0+EDR

With the introduction of the EDR feature and updates to errata found in v1.2, the *Bluetooth* SIG defined the latest core system specification v2.0+EDR. This specification has all the functional characteristics of v1.2 with the addition of two new modulation schemes implemented in the payload section of the packet. These EDR packet types provide peak data rates of 2 Mb/s and 3 Mb/s. An increase in the peak data rate beyond the basic rate of 1 Mb/s is achieved by modulating the RF carrier using phase shift keying (PSK) techniques, resulting in an increase of two to three times the number of bits per symbol. The 2 Mb/s EDR packets use a $\pi/4$ -DQPSK modulation and the 3 Mb/s EDR packets use 8DPSK modulation. Additional information regarding EDR modulation schemes is provided in the section of this application note entitled, *Basic rate and EDR packet format*. The $\pi/4$ -DQPSK modulation is a mandatory function in any v2.0+EDR compliant radio. The 8DPSK modulation type is optional.

To maintain backward compatibility to v1.2, a mandatory mode, called the basic rate, is required for all *Bluetooth* v2.0+EDR compliant radios. As defined in earlier versions of the core specification, the basic rate uses a GFSK modulation across the entire packet resulting in a peak data rate of 1 Mb/s. It is important to note that the spectrum occupancy is approximately the same for all three-modulation types as a 1 Ms/s symbol rate is maintained for both the basic rate and EDR packet types. There is a slight increase in occupied bandwidth when using EDR modulation as root-raised cosine filters are used in place of the narrower Gaussian filter implemented in the basic rate packets. The FCC has accepted the use of *Bluetooth* EDR radios in the 2.4 GHz ISM band by relaxing the -20 dB occupied bandwidth requirement from 1.0 MHz to 1.5 MHz.

Market Drivers for Bluetooth EDR

Bluetooth was designed as a way of providing short-range wireless connection between personal, portable, and handheld devices. Initially serving as a cable replacement, *Bluetooth* devices have found consumer applications in wireless headsets and for data exchange and synchronizing between PCs, PDAs, digital cameras, and printers. Devices in a *Bluetooth* piconet form a spontaneous personal area network (PAN) around the user. Any *Bluetooth* device entering the piconet can be connected to any other device in the PAN. Additionally a *Bluetooth* device can access a local area network (LAN) or wide area network (WAN) through a personal gateway device having networking capability. For example, a *Bluetooth*-enabled PC can access the internet through a *Bluetooth*-enabled cellular phone that is connected to a WAN data service.

As *Bluetooth* technology found its way into a variety of consumer products, expanding into new applications requires higher data rates and longer battery life. For example, consumer demand for short-range wireless connectivity is moving beyond running a single application into a desire to run multiple applications within the same PAN. High bandwidth applications such as stereo audio running simultaneously with wireless input/output devices, such as a mouse, keyboard, and printer, and other multimedia and gaming applications place high demands on the *Bluetooth* system. With the introduction of EDR, multiple applications can more effectively utilize the available bandwidth and achieve higher overall performance. Figure 2 shows a typical multi-use scenario with a variety of high data rate applications operating in the same PAN. The extra capacity provided by EDR supports simultaneous operation of these consumer appliances. As a result of the higher data rates provided by EDR transmission, the radio electronics are on for less time, consuming much less power and increasing the battery life of the wireless appliance.



Figure 2. Simultaneous connections of multiple *Bluetooth* EDR-capable appliances operating in a personal area network

Packet Structure and Modulation Format

Basic rate and EDR packet format

A typical *Bluetooth* packet begins with an access code and header. The access code is used for synchronization, DC-offset compensation, and identification of the packets in the physical channel. Access codes are also used in paging, inquiry, and park operations in a *Bluetooth* system. The header contains link control information that includes the packet type. There are 15 different packet types covering the three different logical transports [1]. As mentioned previously, the three logical transports or link types are ACL, SCO, and eSCO. The link type determines the format of the payload that follows the access code and header. The payload may contain user and control information. The user information may consist of data or voice or a combination of the two. The payload may also contain control data used for device identity and provide real-time clock information. The payload may also contain additional data for error discovery and recovery such as the cyclic redundancy check (CRC) and forward error correction (FEC) information. Figure 3 shows the general packet format or basic rate packet format. The general packet is now referenced as the basic rate packet in v2.0+EDR after the introduction of the EDR packet. The basic rate packet is transmitted with a Gaussian frequency shift keying (GFSK) modulation across the entire waveform.

The key characteristic of the EDR packet is the change in modulation to differential phase shift keying (DPSK) following the packet header. As a result, additional timing and control information is required for synchronizing to the new modulation format. The EDR packet uses the same access code and header definitions as the basic rate packet, including the modulation format. Following the header, the EDR packet contains a short time period that allows the *Bluetooth* radio time to prepare for the change in modulation to DPSK. This short time or guard time is specified to be between 4.75 μ s and 5.25 μ s. The guard time is followed by a synchronization sequence that contains one reference symbol and ten DPSK symbols. This sequence is required for synchronizing the symbol timing and phase for one of the two modulation types used in an EDR packet. The payload in the EDR packet may contain user and control information based on the type of packet transmitted. Figure 4 shows the format for an EDR packet.



Figure 3. *Bluetooth* basic rate packet format

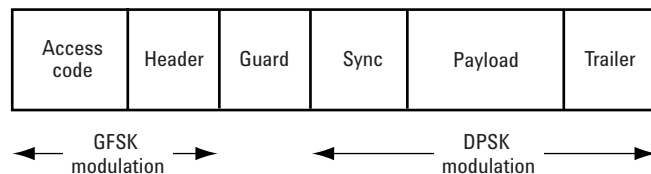

Figure 4. *Bluetooth* EDR packet format

Basic rate and EDR modulation format

The general or basic rate modulation is GFSK. Data is transmitted using one bit per symbol at a data rate of 1 Mb/s. The symbol rate is then 1 Ms/s. The data is modulated onto the RF carrier using a shift or deviation in the carrier frequency of a minimum of 115 kHz. The binary one is represented by a positive frequency deviation and the binary zero is represented by a negative frequency deviation. FSK-modulated signals have a constant envelope which is desirable for improving the power efficiency of transmit amplifiers. The Gaussian pulse shaping provides spectral efficiency for *Bluetooth* the signal by maintaining a -20 dB bandwidth of 1 MHz.

The EDR modulation format uses one of two types of DPSK in the payload section of the packet. As shown in Figure 4, the EDR packet begins using GFSK modulation during the access code and header portions of the packet but changes to DPSK modulation after the guard time. Changing to a DPSK format allows increased data rates of 2 Mb/s or 3 Mb/s. The increase in data rate is achieved by transmitting two or three bits per symbol while maintaining the specified 1 Ms/s symbol rate.

Figure 5a shows a power versus time measurement for an EDR packet using GFSK modulation during the access code and header, and 8-DPSK modulation during the payload. Figure 5b shows the same power versus time measurement on an expanded scale during the time when the modulation changes from GFSK to DPSK. This figure shows the $5\text{-}\mu\text{s}$ guard time and the eleven synchronization bits at the beginning of the EDR payload. It is interesting to observe the relatively constant amplitude during the GFSK-modulated portion of the packet and the large variation in amplitude that occurs during the DPSK modulated waveform. Spectral efficiency is achieved by using root-raised cosine pulse shaping resulting in a -20 dB bandwidth of 1.5 MHz, which is slightly larger than the bandwidth for GFSK modulation format.

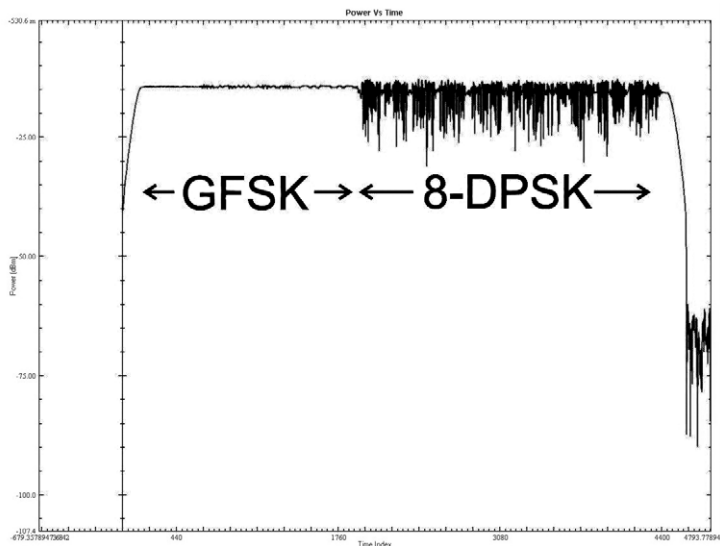

Figure 5a. Power versus time measurement for an EDR packet showing the GFSK and 8-DPSK modulated sections of the packet.) This waveform was captured using the Agilent N4017A Graphical Measurement Application (GMA) with Option 205 for *Bluetooth* EDR testing)

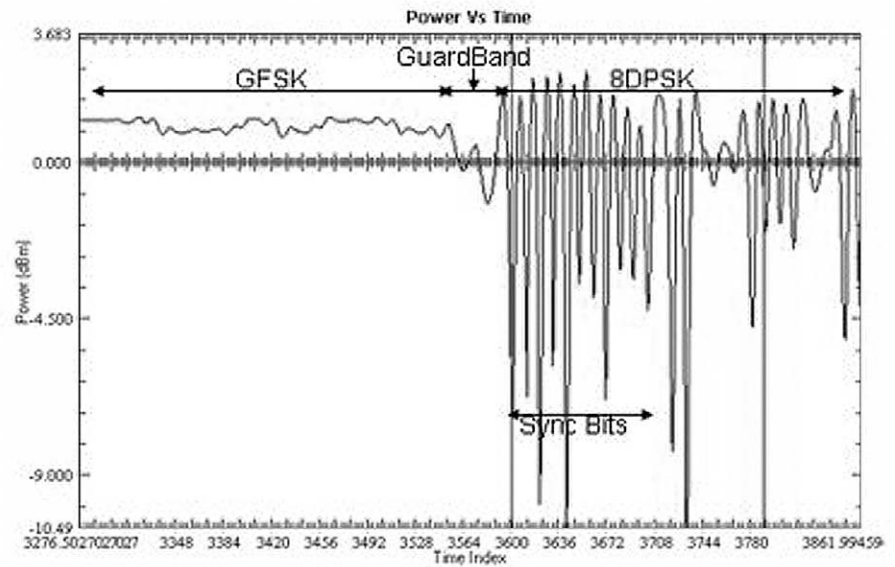

Figure 5b. Power versus time waveform displaying the transition between GFSK and 8DPSK modulation schemes

The DPSK modulation format defined for 2 Mb/s transmission is the $\pi/4$ rotated differential encoded quaternary phase shift keying ($\pi/4$ -DQPSK). A differentially encoded phase modulated signal has the advantage that the signal can be demodulated without estimating the carrier phase. Instead, the received signal in any given symbol time is compared to the phase of the preceding symbol [4]. The amount of phase shift is used to estimate the received data. The $\pi/4$ -DQPSK constellation can be viewed as the superposition of two QPSK constellations offset by 45 degrees relative to each other. Symbol phases are alternately selected from one QPSK constellation to the other for each symbol time. As a result, successive symbols have a relative phase difference that is one of four angles $\pm\pi/4$ and $\pm3\pi/4$. In degrees, these phase angle represent ±45 degrees and ±135 degrees. The four possible constellation points result in a two-bit per symbol transmission rate that translates to a two times increase in data rate over the general GFSK modulation scheme. The symbol transitions from one constellation to the other always guarantees that there is a phase change between symbols, making clock recovery easier [5].

The $\pi/4$ -DQPSK modulation has several advantages when used in mobile applications when compared to other PSK modulations such as QPSK and offset-QPSK (OQPSK). The $\pi/4$ -DQPSK scheme allows demodulation using a differential detector or a discriminator followed by an integrate-and-dump filter. These two demodulator types result in low-complexity receiver architectures when compared to demodulators requiring coherent detection. In addition, the transitions in the signal constellation of a $\pi/4$ -DQPSK waveform do not pass through the origin resulting in improved spectral characteristics and power consumption when compared to other QPSK waveforms. Figure 6 shows the $\pi/4$ -DQPSK constellation for the EDR portion of a *Bluetooth* packet. This figure shows a measurement over many symbols resulting in the eight desired constellation points. Note that during any one symbol time only four constellation points or transitions are available. This figure shows the combination of two separate QPSK constellations rotated by 45 degrees relative to each other.

The second EDR modulation format defined for 3 Mb/s transmission is the 8-ary differential encoded phase shift keying (8-DPSK). The further increase in data rate is achieved through the addition of four more constellation points for each symbol. The total of eight constellation points allow a transmission rate of three bits per symbol resulting in a three-fold improvement in data rate over the GFSK modulation scheme. This type of modulation has many of the same benefits as $\pi/4$ -DQPSK including non-coherent demodulation schemes. Demodulation of an 8-DPSK occurs by examining the relative phase difference between successive symbols resulting in phase angles of $0, \pm\pi/4, \pm\pi/2, \pm3\pi/4,$ and π . The increase in data rate does not come without a penalty, as an 8-DPSK modulated signal is more sensitive to noise due to smaller separation between constellation points when compared to $\pi/4$ -DQPSK and GFSK signals. Also, transitions through the origin are now possible thus requiring better linearity in the power amplifiers. Lastly, having a state requiring a zero phase transition between symbols eliminates the clock recovery benefits found in the $\pi/4$ -DQPSK demodulator.

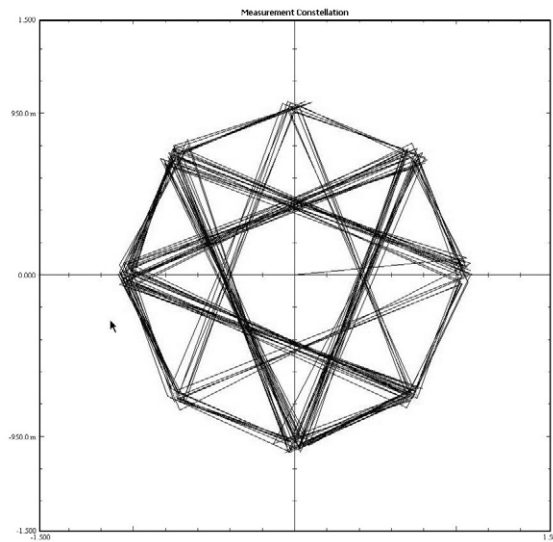

Figure 6. Measurement constellation of an EDR payload using a $\pi/4$ -DQPSK modulation

New Test Procedures and Test Cases for EDR

With the introduction of EDR to the *Bluetooth* core specification, additional EDR-specific measurements have been added to the RF layer test procedure and specification (TSS/TP) [2]. The *Bluetooth* SIG created the test specification in order to provide a set of conformance tests for the air interface and interoperability among *Bluetooth* devices. The RF test cases called out in the TSS/TP allow provisional testing of *Bluetooth* devices under non-loop back operation, which may be very useful during the early stages of radio development. The EDR tests specific to transmitters include relative transmit power, carrier frequency stability and modulation accuracy, and differential phase encoding. The EDR tests specific to the *Bluetooth* receiver include EDR sensitivity, EDR bit error rate (BER) floor performance, and EDR maximum input level.

The TSS/TP specification uses the test purposes (TP) terminology that includes specific identifiers for the various types of test. For example, TRM is the identifier for transmitter tests and RCV is the identifier for receiver tests. CA is a sub group identifying the test of the major device capabilities. C is to describe a conformance test type. Also included is an integer number to identify the TP number. The TP identifiers will be shown for each relevant section and can be used to reference additional information within the TSS/TP document [2].

Measurement examples will be given using the Agilent N4010A Wireless Connectivity Test Set configured with Option 105 for *Bluetooth* EDR transmit and receive testing. The N4010A can also be configured with a lower-cost alternative for transmitter-only testing using Option 106. Measurement results will be displayed using the PC-based N4017A *Bluetooth* Graphical Measurement Applications (GMA) with Option 205 for EDR analysis. The N4017A GMA also provides an interface for directly controlling the N4010A test set. A typical measurement configuration for testing an EDR-capable *Bluetooth* radio is shown in Figure 7. For this configuration, the RF signals are transmitted and received between the test instrument and radio over a coaxial connection. Alternately, antennas can be used at the test set and the radio for over-the-air testing. The N4010A test set is controlled using the N4017A GMA and the radio is controlled using a device driver resident on the PC. This configuration will be used for the measurement examples of a *Bluetooth* EDR transmitter.

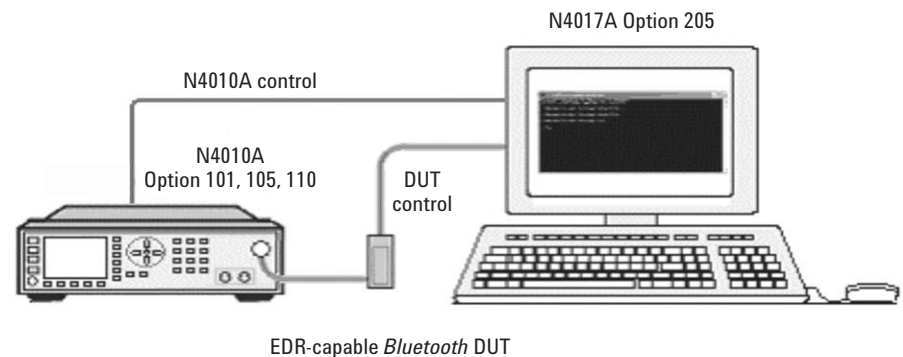

Figure 7. Measurement configuration for testing a *Bluetooth* EDR radio using the Agilent N4010A test set and N4017A Graphical Measurement Application

Bluetooth transmitter test cases for EDR

EDR relative transmit power (TRM/CA/10/C)

Bluetooth EDR transmitter testing requires measuring the modulation quality, carrier frequency stability, and power levels of the various components within the transmitted packet. The test equipment, such as the Agilent N4010A test set, requires the capability to demodulate an EDR waveform and measure the modulation accuracy of the DPSK signal. When developing a Bluetooth transmitter, the TSS/TP allows for provisional testing of the transmitter performance in non-loop back mode. The Agilent N4010A test set with Option 105 is configured for non-loop back testing of the radio transmitter. For this case, the Bluetooth transmitter modulates a pseudo random bit sequence (PRBS) into the EDR packet and the test equipment demodulates the binary sequence. The test equipment then measures the modulation accuracy and frequency stability of the transmitted EDR signal. Measurement examples will be provided using the equipment configuration shown in Figure 7 above.

The EDR relative transmit power verifies that the difference between the average transmit power during the GFSK modulation and the average transmit power during the DPSK modulation is within a specified range. The Bluetooth core specification places the average power within the GFSK portion of the signal at -1 and $+4$ dB from the average power of the DPSK signal [1]. The relative power is calculated by taking the difference of an average power measurement taken over at least 80 percent of the GFSK portion of the packet to an average power measurement taken over at least 80 percent of the DPSK portion. The test conditions require that the transmitter is operating with the highest output power, and that the frequency hopping and whitening be turned off. The measurements are made at the low, mid, and high frequencies across the ISM band. These measurements are repeated using the minimum output power from the transmitter. Figure 8 shows the relative transmit power measurement of an EDR signal using $\pi/4$ -DQPSK modulation with the RF carrier at the mid-band frequency of 2441 MHz. As shown in Figure 8, the average power measurement for the GFSK and $\pi/4$ -DQPSK waveforms is -14.4 dBm and -16.22 dBm respectively. The relative transmit power is calculated as $+1.82$ dB and is within the specified difference of -1 and $+4$ dB.

Result Type	Run?	Result Value	Pass/Fail	Test to Limits?	Lower Limit	Upper Limit
Differential Phase Encoding	<input checked="" type="checkbox"/>			<input checked="" type="checkbox"/>		
Modulation Accuracy	<input checked="" type="checkbox"/>			<input checked="" type="checkbox"/>		
Relative Transmit Power	<input checked="" type="checkbox"/>			<input checked="" type="checkbox"/>		
Average Guard Interval		4.9 μ s				
Calculated Packet Type		2-DH1				
Power Difference		1.82 dB	Pass		-1.00	4.00
DPSK Power		-16.22 dBm				
GFSK Power		-14.4 dBm				

Figure 8. Measurement of the relative transmit power for an EDR packet using $\pi/4$ -DQPSK modulation

**EDR carrier frequency stability
and modulation accuracy
(TRM/CA/11/C)**

The EDR carrier frequency stability test verifies the frequency stability for the transmitter's RF center frequency carrier. The EDR modulation accuracy test verifies the quality of the differential modulation and is intended to highlight errors that would cause problems to a real differential receiver. The modulation accuracy is tested using a differential error vector magnitude (DEV_M) measurement. The DEV_M measurement is similar to the traditional error vector magnitude (EVM) measurement specified in other digital communication systems [5]. The basic EVM measurement represents the magnitude of the error between an ideal signal and the actual received signal. The DEV_M defined in the *Bluetooth* core specification represents the magnitude of the error between two received signals spaced one symbol apart in time. The error is measured after all linear distortions are removed from the received signal, which includes tracking the frequency drift of the carrier.

The DEV_M measurement is made over the synchronization sequence and payload portion of the packet. The test conditions require that hopping and whitening be turned off. Prior to calculating the DEV_M values, the sample sequence is adjusted to compensate for carrier frequency drift and sample timing phase error over blocks of 50 symbols. A total of 200 non-overlapping blocks are required for each carrier frequency. For a transmitter with no distortions other than a constant frequency error, the differential error sequence would be zero.

The modulation accuracy is reported as three separate values, the 99% DEV_M, RMS DEV_M, and peak DEV_M. The 99% DEV_M is defined as the DEV_M value for which 99 percent of the measured symbols have a lower DEV_M value than 0.3 for $\pi/4$ -DPSK and 0.2 for 8-DPSK. The RMS and peak DEV_M values are also calculated using this same error sequence. An RMS DEV_M is calculated over the 50 symbols for each block. Note that this computation includes information from the symbol immediately before the block in order to generate the 50 differential error vectors. The worst-case RMS value over the 200 measured blocks is reported as the RMS DEV_M. The RMS DEV_M for $\pi/4$ -DQPSK and 8-DPSK modulation types are specified as a maximum of 0.2 and 0.13 respectively. The peak DEV_M is reported as the worst-case DEV_M over all symbols in the measured blocks. The peak DEV_M measurement limits for $\pi/4$ -DQPSK and 8-DPSK formats are 0.35 and 0.25 respectively.

Table 1 shows the specified limits for the three DEVM measurements over the two types of EDR modulation. The maximum values in the table are shown as percentages of the specified limits. Figure 9 shows the modulation accuracy for a *Bluetooth* packet using $\pi/4$ -DQPSK modulation. The 99% DEVM, peak DEVM, and RMS DEVM values for this packet are measured and reported in percentages as 10.24, 11.57, and 5.5 percent respectively. As shown in the figure, all measured DEVM values for this waveform are within the required specifications for the $\pi/4$ -DQPSK modulated EDR packet type.

Table 1. Maximum DEVM limits

DEVM measurement	$\pi/4$ -DQPSK	8-DPSK
99%	30%	20%
RMS	20%	13%
Peak	35%	25%

Result Type	Run?	Result Value	Pass/Fail	Test to Limits?	Lower Limit	Upper Limit
Differential Phase Encoding	<input checked="" type="checkbox"/>			<input checked="" type="checkbox"/>		
Modulation Accuracy	<input checked="" type="checkbox"/>			<input checked="" type="checkbox"/>		
Secondary Results						
99% DEVM		10.24 %	Pass		0.00	40.00
Max Peak DEVM		11.57 %	Pass		0.00	35.00
Max RMS DEVM		5.5 %	Pass		0.00	20.00
$\omega_i + \omega_0$		-6853.77 Hz	Pass		-75000.00	75000.00
ω_0 Block Frequency Error		-857.27 Hz	Pass		-10000.00	10000.00
ω_i Initial Frequency Error		-5996.5 Hz	Pass		-75000.00	75000.00
DEVM Blocks						
Relative Transmit Power	<input checked="" type="checkbox"/>			<input checked="" type="checkbox"/>		

Figure 9. Measurement of the DEVM modulation accuracy for a *Bluetooth* EDR packet; also shown are the carrier frequency stability measurements over the entire packet

The measurement of frequency stability occurs over the GFSK and DPSK portions of the waveform. The test conditions require that hopping and whitening be turned off. The payload data uses a PRBS9 pseudo-random pattern. The measurement begins with a determination of the initial center frequency error in the GFSK header by using bit sequences with low inter-symbol interference. The frequency deviations in logic 1 bits and logic 0 bits are measured and reported as $\Delta\omega_1$ and $\Delta\omega_2$ respectively. The initial frequency error is calculated as the average frequency error between logic 1 and logic 0 bits and reported as the initial frequency error, ω_i ($\omega_i = [\Delta\omega_1 + \Delta\omega_2] / 2$). The initial frequency error is specified between ± 75 kHz. The frequency error in the EDR portion of the packet is corrected using the initial frequency error, ω_i . The corrected waveform is then partitioned into blocks of 50 symbols in length. The remaining frequency error in each block is reported as ω_0 . The measurement continues over 200 non-overlapping blocks. The worst-case block frequency error, ω_0 , is specified to be within ± 10 kHz. Lastly, the *Bluetooth* specification limits the maximum value of the combined frequency errors, $\omega_i + \omega_0$, to ± 75 kHz. This value represents the maximum excursion of the frequency error, which includes the initial error in the access code and the frequency drift that may occur over the measured blocks.

Figure 10 shows the carrier frequency tolerance limits over different portions of the EDR packet. The initial frequency error limit of ± 75 kHz occurs over the access code (GFSK) portion of the packet. The remainder of the packet is then corrected for the initial error and the block frequency errors over the header, sync, payload, trailer symbols, and the limits are reduced to ± 10 kHz. The figure also shows the limits for the combined error or maximum excursion as ± 75 kHz. As a measurement example, Figure 9 also shows the frequency stability results from an EDR waveform in tabular form. In this case, the initial frequency stability is measured as -5.997 kHz, the block frequency error is -0.857 kHz and combined frequency error as -6.854 kHz. All these measured values are shown to be within the required specifications.

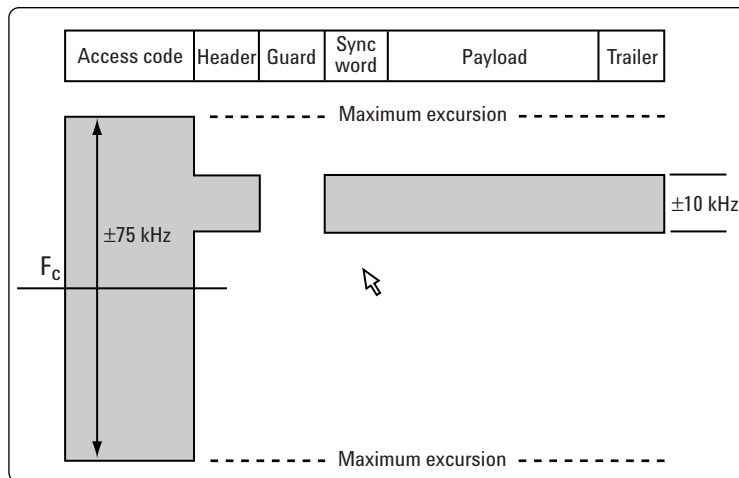

Figure 10. *Bluetooth* EDR carrier frequency stability limits as a function of the symbol position

EDR differential phase encoding (TRM/CA/12/C)

The differential phase encoding test verifies the operation of the differential PSK modulator. For the EDR payload, the modulator is required to correctly map the binary data stream into a set of specified phase angles in the complex plane. The test conditions require that frequency hopping and whitening be turned off and that the transmitter output power level be set to maximum. The EDR payload is modulated with a PRBS9 sequence and a packet error rate measurement is performed over 100 packets.

In this case the test equipment is required to demodulate the payload and verify that packets contain the expected PRBS9 sequence. It is specified that 99 percent of the packets be received with no bit errors, or in other words, that the packet error rate is less than one percent. As a measurement example, the Agilent N4010A test set is used to demodulate the PRBS9 payload and the results are displayed using the N4017A software. Figure 11 shows the packet error rate for an EDR packet using $\pi/4$ -DQPSK modulation. In this case no bit errors were detected resulting in a zero percent packet error rate. The N4017A data display also shows the total number of bits measured and the associated bit error rate for this test. Where a single reported packet error could result from one or more bit errors occurring in the packet, the bit error rate provides additional information reporting the total number of errors occurring in the demodulated packets.

The measurement of the guard interval is also shown in Figure 11. This measurement is also available in all the individual EDR transmitter tests discussed above. The guard interval is reported as minimum, maximum, and average value over all the packets measured during the test. As shown in Figure 11, the average guard interval measured over 100 packets is 4.94 μs with the minimum and maximum times of 4.9 and 5.0 μs respectively.

Result Type	Run?	Result Value	Pass/Fail	Test to Limits?	Lower Limit	Upper Limit
Differential Phase Encoding	<input checked="" type="checkbox"/>			<input checked="" type="checkbox"/>		
Secondary Results						
Mini Guard Interval		4.9 μs				
Max Guard Interval		5 μs				
Average Guard Interval		4.94 μs				
Bit Error Rate		0 %				
Number of Bit Errors		0				
Number of Bits		43200				
Packet Error Rate		0 %	Pass		0.000000	1.000000
Number of Correct Packets		100				
Number of Packets		100				
Modulation Accuracy	<input checked="" type="checkbox"/>			<input checked="" type="checkbox"/>		
Relative Transmit Power	<input checked="" type="checkbox"/>			<input checked="" type="checkbox"/>		

Figure 11. Measurement of the packet error rate and bit error rate for an EDR waveform

Bluetooth receiver test cases for EDR

Bluetooth EDR receiver testing requires measuring the BER performance using test signals containing a variety of frequency and timing impairments. The test equipment, such as the Agilent N4010A test set, will typically use an internal arbitrary waveform generator to create signal impairments in the EDR packets. These “dirty packets” will then be supplied to a Bluetooth EDR receiver for demodulation. When developing a Bluetooth receiver, the TSS/TP allows for provisional testing of the receiver performance in non-loop back mode. For this case, the test equipment modulates a PRBS sequence into the EDR packet and the receiver under test demodulates the binary sequence. The receiver BER performance is calculated by comparing the received data to the original PRBS sequence transmitted by the test equipment. In this case, the software controlling the receiver under test is typically configured to perform the BER calculation.

EDR sensitivity (RCV/CA/07/C)

The receiver sensitivity is measured using EDR packets corrupted with timing errors and frequency offsets in the transmitted carrier. The conditions for these dirty packets are specified in the Bluetooth TSS/TP document [2]. The test equipment is required to send three groups of 20 packets containing different impairments. The first group of packets contains no impairments. The second group of packets contains a carrier frequency offset of +65 kHz and a symbol timing error of +20 ppm. The third group of packets contains a carrier frequency offset of -65 kHz and a symbol timing error of -20 ppm. The groups are repeated until a minimum of 16,000,000 bits of data has been received.

The BER is then calculated by comparing the received data to the transmitted PRBS9 sequence.

To simulate a worst-case condition of carrier frequency stability in a transmitter, an additional signal is modulated onto the EDR packet at the beginning of the DPSK synchronization word. The modulation uses a synchronized ± 10 kHz sine wave created by the test equipment using the arbitrary waveform generator. The receiver BER performance is required to be $10e-4$ using a transmitted signal corrupted by these frequency and timing impairments. Figure 12 shows the Agilent N4017A GMA menu for entering the parameters of a dirty packet. In this case, the N4010A test set provides the impaired EDR signal to the receiver under test.

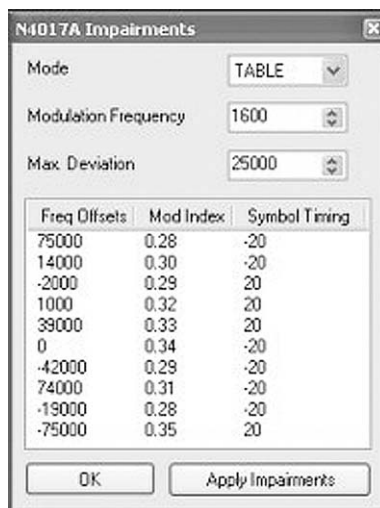

Figure 12. Agilent N4017A signal impairments menu for creating dirty packets in an EDR waveform

**EDR BER floor performance
(RCV/CA/08/C)**

The receiver floor performance is a measurement of the BER under a received power level of -60 dBm. This test simulates the receiver performance when a practical transmitter and receiver are spaced far apart in physical distance or under certain non-line-of-sight operating conditions. For example, using a Power Class 1 *Bluetooth* transmitter capable of transmitting the maximum specified power level of $+20$ dBm, a received signal of -60 dBm represents an ideal free space loss of 80 dB corresponding to a distance of 100 meters [6]. For the BER floor performance measurement, the test equipment is required to transmit a $\pi/4$ -DQPSK or 8-DPSK modulated signal using a PRBS9 payload with an output power level of -60 dBm. The receiver demodulates the data sequence until $16,000,000$ bits have been received. The BER is then calculated by comparing the received data to the transmitted PRBS9 sequence. Under these conditions the BER performance is specified as $10e-5$ measured at the low, mid, and high carrier frequencies.

**EDR BER floor performance
(RCV/CA/08/C)**

The maximum input level test shows the receiver BER performance when the input signal level is -20 dBm. This test shows the receiver performance under possible front-end compression when driven with a high input power level. For this measurement, the test equipment is required to transmit a $\pi/4$ -DQPSK or 8-DPSK modulated signal using a PRBS9 payload with an output power level of -20 dBm. The receiver demodulates the data sequence until $16,000,000$ bits have been received. The BER is then calculated by comparing the received data to the transmitted PRBS9 sequence. The BER performance is specified as $10e-3$ measured at the low, mid, and high carrier frequencies.

Future Directions for *Bluetooth* EDR

The higher data rates, improved power consumption, and demand for multi-media applications such as audio and video streaming is expected to drive the transition to EDR-capable devices. The EDR evolution will continue to promote the concept of the personal area network by providing multi-use scenarios where numerous devices operate concurrently in the same piconet. In addition, new portable devices are anticipated to combine several wireless interfaces, such as GPRS and WiFi with *Bluetooth* EDR, in order to provide simultaneous and seamless connectivity across multiple networks.

The concept of the *Bluetooth* personal area network has also expanded into automotive telematics. Telematics is the integration of wireless communications, automatic driving assistance, remote diagnostics, and GPS navigation within the automobile experience. Studies show that 20 to 30 percent of cellular use occurs while driving, and factory-fitted *Bluetooth* hardware is expected to reach 22 million in 2008. Automobile manufacturers are no longer required to install cell phones directly into the vehicle, but rather, by using a *Bluetooth* connection, the vehicle's audio system can be connected to a user-selected cell phone over the wireless link. In addition, portable navigation, MP3, and WAN devices can also be integrated in the automotive environment using the higher data rates available in the EDR-capable devices.

Bluetooth v2.0+EDR is just one step in the evolution of this short-range, ad-hoc technology. In May 2005, the *Bluetooth* SIG announced that ultra-wideband (UWB) technology would become an integral part of the *Bluetooth* specification. The addition of UWB will allow *Bluetooth* to meet future industry demands for high-quality streaming video and transferring large amounts of data between wireless devices. The *Bluetooth* SIG is currently working on the details to incorporate UWB into next generation systems while maintaining backward compatibility with v2.0+EDR and earlier version devices.

Appendix A: Symbols and Acronyms

8-DPSK	8-ary differential encoded phase shift keying
ACL	Asynchronous connectionless link
AFH	Adaptive frequency hopping
BER	Bit error rate
C	Denotes conformance test type
CA	Denotes capabilities of major device
CRC	Cyclic redundancy check
dB	Decibels
dBc	Decibels relative to the carrier frequency
dBm	Decibels relative to 1 milliwatt ($10\log(\text{power}/1\text{mW})$)
DEVM	Differential error vector magnitude
DPSK	Differential phase shift keying
DSSS	Direct sequence spread spectrum
eSCO	Extended SCO
EDR	Enhanced data rate
EVM	Error vector magnitude
FCC	Federal Communications Commission
FEC	Forward error correction
FHSS	Frequency hopping spread spectrum
GFSK	Gaussian frequency shift keying
GMA	Graphical measurement application
GPRS	General packet radio service
GPS	Global positioning system
Hz	Hertz or cycles/second
ISM	Industrial, Scientific, and Medical radio band
L2CAP	Logical link control and adaptation
LAN	Local area network
LC	Link control
LM	Link manager
MP3	Audio Layer-3 compression scheme
OFDM	Orthogonal frequency division multiplexing
OQPSK	Offset QPSK
PAN	Personal area network
PDA	Personal digital assistant
$\pi/4$ -DQPSK	$\pi/4$ rotated differential encoded quaternary phase shift keying
PRBS	Pseudo random bit sequence
PSK	Phase shift keying
QPSK	Quaternary phase shift keying
RCV	Receiver tests
RF	Radio frequency
SCO	Synchronous connection-oriented link
SIG	<i>Bluetooth</i> Special Interest Group
TP	Test purposes
TRM	Transmitter tests
TSS/TP	Test suite structure and test purposes
TDD	Time division duplex
UWB	Ultra wide band
WAN	Wide area network
WiFi	Wireless fidelity radio technology based on the IEEE 802.11
WLAN	Wireless LAN

Appendix B: References

- [1] *Specification of the Bluetooth System, Version 2.0+EDR, Specification Volume 1 Architecture & Terminology Overview & Volume 2 Core System Package*, November 4, 2004
- [2] *Radio Frequency Test Suite Structure (TSS) and Test Purposes (TP) System Specification 1.2/2.0/2.0+EDR, March 21, 2005, Rev. 2.0.E.3*, Document Number RFTS/2.0.E.3
- [3[MEK1]] Philips Semiconductors White Paper, *“How 802.11b/g WLAN and Bluetooth Can Play Together”* Document 9397-750-13426, June 2004
- [4] J.G. Proakis, *“Digital Communications”*, 3rd ed., McGraw-Hill,1995, pg 274-275
- [5] *Digital Modulation in Communications Systems - An Introduction Agilent Application Note 1298*, 5965-7160E, March 14, 2001
- [6] J.G. Proakis, *“Digital Communications”*, 3rd ed., McGraw-Hill,1995, pg 317



Agilent Email Updates

www.agilent.com/find/emailupdates

Get the latest information on the products and applications you select.



Agilent Direct

www.agilent.com/find/agilentdirect

Quickly choose and use your test equipment solutions with confidence.



Agilent Open

www.agilent.com/find/open

Agilent Open simplifies the process of connecting and programming test systems to help engineers design, validate and manufacture electronic products. Agilent offers open connectivity for a broad range of system-ready instruments, open industry software, PC-standard I/O and global support, which are combined to more easily integrate test system development.

www.agilent.com

Agilent Technologies' Test and Measurement Support, Services, and Assistance

Agilent Technologies aims to maximize the value you receive, while minimizing your risk and problems. We strive to ensure that you get the test and measurement capabilities you paid for and obtain the support you need. Our extensive support resources and services can help you choose the right Agilent products for your applications and apply them successfully. Every instrument and system we sell has a global warranty. Two concepts underlie Agilent's overall support policy: "Our Promise" and "Your Advantage."

Our Promise

Our Promise means your Agilent test and measurement equipment will meet its advertised performance and functionality. When you are choosing new equipment, we will help you with product information, including realistic performance specifications and practical recommendations from experienced test engineers. When you receive your new Agilent equipment, we can help verify that it works properly and help with initial product operation.

Your Advantage

Your Advantage means that Agilent offers a wide range of additional expert test and measurement services, which you can purchase according to your unique technical and business needs. Solve problems efficiently and gain a competitive edge by contracting with us for calibration, extra-cost upgrades, out-of-warranty repairs, and onsite education and training, as well as design, system integration, project management, and other professional engineering services. Experienced Agilent engineers and technicians worldwide can help you maximize your productivity, optimize the return on investment of your Agilent instruments and systems, and obtain dependable measurement accuracy for the life of those products.

For more information on Agilent Technologies' products, applications or services, please contact your local Agilent office.

Phone or Fax

United States:

(tel) 800 829 4444
(fax) 800 829 4433

Canada:

(tel) 877 894 4414
(fax) 800 746 4866

China:

(tel) 800 810 0189
(fax) 800 820 2816

Europe:

(tel) 31 20 547 2111

Japan:

(tel) (81) 426 56 7832
(fax) (81) 426 56 7840

Korea:

(tel) (080) 769 0800
(fax) (080) 769 0900

Latin America:

(tel) (305) 269 7500

Taiwan:

(tel) 0800 047 866
(fax) 0800 286 331

Other Asia Pacific Countries:

(tel) (65) 6375 8100
(fax) (65) 6755 0042

Email: tm_ap@agilent.com

Contacts revised: 09/26/05

**The complete list is available at:
www.agilent.com/find/contactus**

Product specifications and descriptions in this document subject to change without notice.

© Agilent Technologies, Inc. 2005
Printed in USA, December 6, 2005
5989-4204EN



Agilent Technologies

射频和天线设计培训课程推荐

易迪拓培训(www.edatop.com)由数名来自于研发第一线的资深工程师发起成立,致力并专注于微波、射频、天线设计研发人才的培养;我们于 2006 年整合合并微波 EDA 网(www.mweda.com),现已发展成为国内最大的微波射频和天线设计人才培养基地,成功推出多套微波射频以及天线设计经典培训课程和 ADS、HFSS 等专业软件使用培训课程,广受客户好评;并先后与人民邮电出版社、电子工业出版社合作出版了多本专业图书,帮助数万名工程师提升了专业技术能力。客户遍布中兴通讯、研通高频、埃威航电、国人通信等多家国内知名公司,以及台湾工业技术研究院、永业科技、全一电子等多家台湾地区企业。

易迪拓培训推荐课程列表: <http://www.edatop.com/peixun/tuijian/>



射频工程师养成培训课程套装

该套装精选了射频专业基础培训课程、射频仿真设计培训课程和射频电路测量培训课程三个类别共 30 门视频培训课程和 3 本图书教材;旨在引领学员全面学习一个射频工程师需要熟悉、理解和掌握的专业知识和研发设计能力。通过套装的学习,能够让学员完全达到和胜任一个合格的射频工程师的要求...

课程网址: <http://www.edatop.com/peixun/rfe/110.html>

手机天线设计培训视频课程

该套课程全面讲授了当前手机天线相关设计技术,内容涵盖了早期的外置螺旋手机天线设计,最常用的几种手机内置天线类型——如 monopole 天线、PIFA 天线、Loop 天线和 FICA 天线的设计,以及当前高端智能手机中较常用的金属边框和全金属外壳手机天线的设计;通过该套课程的学习,可以帮助您快速、全面、系统地学习、了解和掌握各种类型的手机天线设计,以及天线及其匹配电路的设计和调试...

课程网址: <http://www.edatop.com/peixun/antenna/133.html>



WiFi 和蓝牙天线设计培训课程

该套课程是李明洋老师应邀给惠普 (HP)公司工程师讲授的 3 天员工内训课程录像,课程内容是李明洋老师十多年工作经验积累和总结,主要讲解了 WiFi 天线设计、HFSS 天线设计软件的使用,匹配电路设计调试、矢量网络分析仪的使用操作、WiFi 射频电路和 PCB Layout 知识,以及 EMC 问题的分析解决思路等内容。对于正在从事射频设计和天线设计领域工作的您,绝对值得拥有和学习! ...

课程网址: <http://www.edatop.com/peixun/antenna/134.html>



CST 学习培训课程套装

该培训套装由易迪拓培训联合微波 EDA 网共同推出,是最全面、系统、专业的 CST 微波工作室培训课程套装,所有课程都由经验丰富的专家授课,视频教学,可以帮助您从零开始,全面系统地学习 CST 微波工作的各项功能及其在微波射频、天线设计等领域的设计应用。且购买该套装,还可超值赠送 3 个月免费学习答疑...

课程网址: <http://www.edatop.com/peixun/cst/24.html>



HFSS 学习培训课程套装

该套课程套装包含了本站全部 HFSS 培训课程,是迄今国内最全面、最专业的 HFSS 培训教程套装,可以帮助您从零开始,全面深入学习 HFSS 的各项功能和在多个方面的工程应用。购买套装,更可超值赠送 3 个月免费学习答疑,随时解答您学习过程中遇到的棘手问题,让您的 HFSS 学习更加轻松顺畅...

课程网址: <http://www.edatop.com/peixun/hfss/11.html>

ADS 学习培训课程套装

该套装是迄今国内最全面、最权威的 ADS 培训教程,共包含 10 门 ADS 学习培训课程。课程是由具有多年 ADS 使用经验的微波射频与通信系统设计领域资深专家讲解,并多结合设计实例,由浅入深、详细而又全面地讲解了 ADS 在微波射频电路设计、通信系统设计和电磁仿真设计方面的内容。能让您在最短的时间内学会使用 ADS,迅速提升个人技术能力,把 ADS 真正应用到实际研发工作中去,成为 ADS 设计专家...

课程网址: <http://www.edatop.com/peixun/ads/13.html>



我们的课程优势:

- ※ 成立于 2004 年,10 多年丰富的行业经验,
- ※ 一直致力并专注于微波射频和天线设计工程师的培养,更了解该行业对人才的要求
- ※ 经验丰富的一线资深工程师讲授,结合实际工程案例,直观、实用、易学

联系我们:

- ※ 易迪拓培训官网: <http://www.edatop.com>
- ※ 微波 EDA 网: <http://www.mweda.com>
- ※ 官方淘宝店: <http://shop36920890.taobao.com>