

*ROHS COMPLIANT

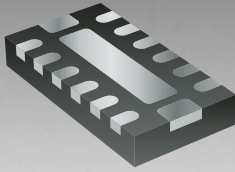

BOURNS®

Features

- Lead free as standard
- RoHS compliant*
- ESD protection
- Protects up to 6 lines
- Bidirectional EMI filtering

Applications

- Cell phones
- PDAs and notebooks
- GPS and SMART cards
- Color LCD display panel

2FAG-M12R Integrated Passive & Active Devices

General Information

The 2FAG-M12R device, manufactured using Thin Film on Silicon technology, provides ESD protection for the external ports of portable electronic devices such as cell phones, notebooks and PDAs.

The ESD protection provided by the component enables a data port to withstand a minimum ± 8 KV Contact / ± 15 KV Air Discharge per the ESD test method specified in IEC 61000-4-2. The device measures 3 mm x 1.4 mm and can be mounted directly onto an FR4 printed circuit board. The device meets typical thermal cycle and bend test specifications without the use of an underfill material.

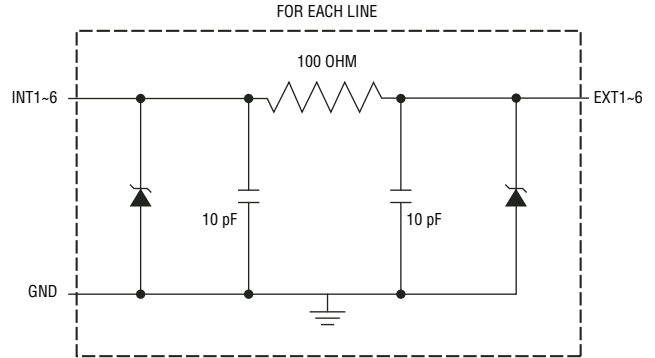

Electrical Characteristics (@ $T_A = 25^\circ\text{C}$ Unless Otherwise Noted)

Parameter	Symbol	Min.	Nom.	Max.	Unit
Resistance	R	80	100	120	Ω
Capacitance @ 2.5 V, 1 MHz	C	16	20	24	pF
Rated Standoff Voltage	V_{WM}		5		V
Breakdown Voltage @ 1 mA	V_{BR}	6			V
Forward Voltage @ 10 mA	V_F		0.8		V
Leakage Current @ 3 V	I_D			0.1	μA
ESD Protection: IEC 61000-4-2					
Contact Discharge		± 8			kV
Air Discharge		± 15			kV
Frequency:					
Attenuation @ 800-3000 MHz	f_c	25	35		db
Cut-off (50 Ω I/O) Zero Bias			150		MHz
DC Power per Resistor	P			100	mW

Thermal Characteristics (@ $T_A = 25^\circ\text{C}$ Unless Otherwise Noted)

Parameter	Symbol	Min.	Nom.	Max.	Unit
Operating Temperature Range	T_J	-40	+25	+85	$^\circ\text{C}$
Storage Temperature Range	T_{STG}	-55	+25	+150	$^\circ\text{C}$

*RoHS Directive 2002/95/EC Jan 27 2003, including Annex Specifications are subject to change without notice. Customers should verify actual device performance in their specific applications.

2FAG-M12R Integrated Passive & Active Devices

BOURNS®

Product Dimensions

This device consists of a DFN package. It consists of 12 I/O pins and 1 ground pin and has a flammability rating of UL 94V-0. The package measures 3 mm x 1.4 mm, weighs approximately 0.10 mg and has a 100 % Sn finish termination.

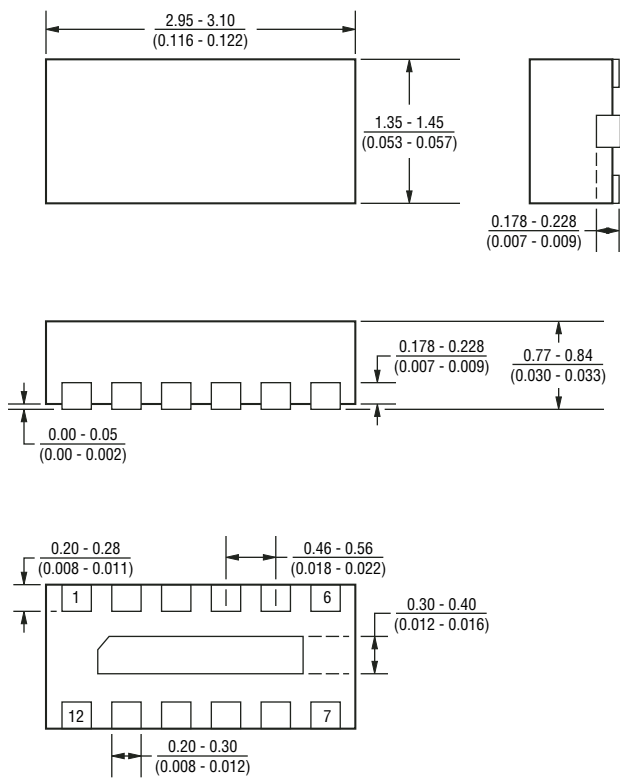

DIMENSIONS = $\frac{\text{MILLIMETERS}}{\text{(INCHES)}}$

Frequency Response

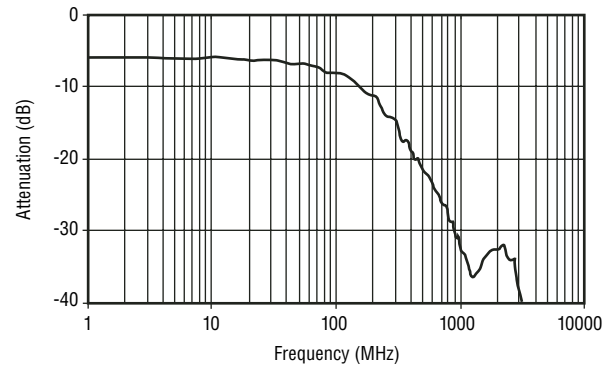

Block Diagram

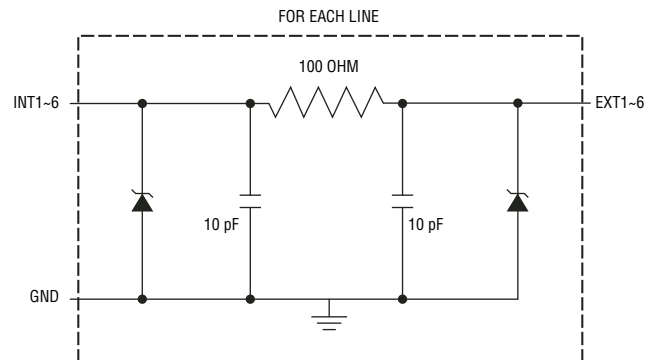

How to Order

2 FAG - M12R

Thinfil _____

Model _____

Micro Leadframe _____

Number of Pads _____

Packaging Option _____

R = Tape and Reel
Packaged 3000 pcs. / 7" reel

Device Pin Out

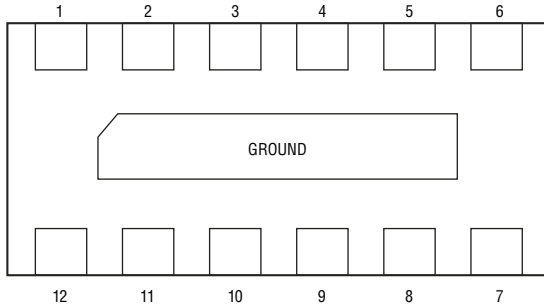

Pin	Function		Function
1	INT 1	7	EXT 6
2	INT 2	8	EXT 5
3	INT 3	9	EXT 4
4	INT 4	10	EXT 3
5	INT 5	11	EXT 2
6	INT 6	12	EXT 1

Packaging

The surface mount product is packaged in a 8 mm x 4 mm Tape and Reel format per EIA-481 standard.

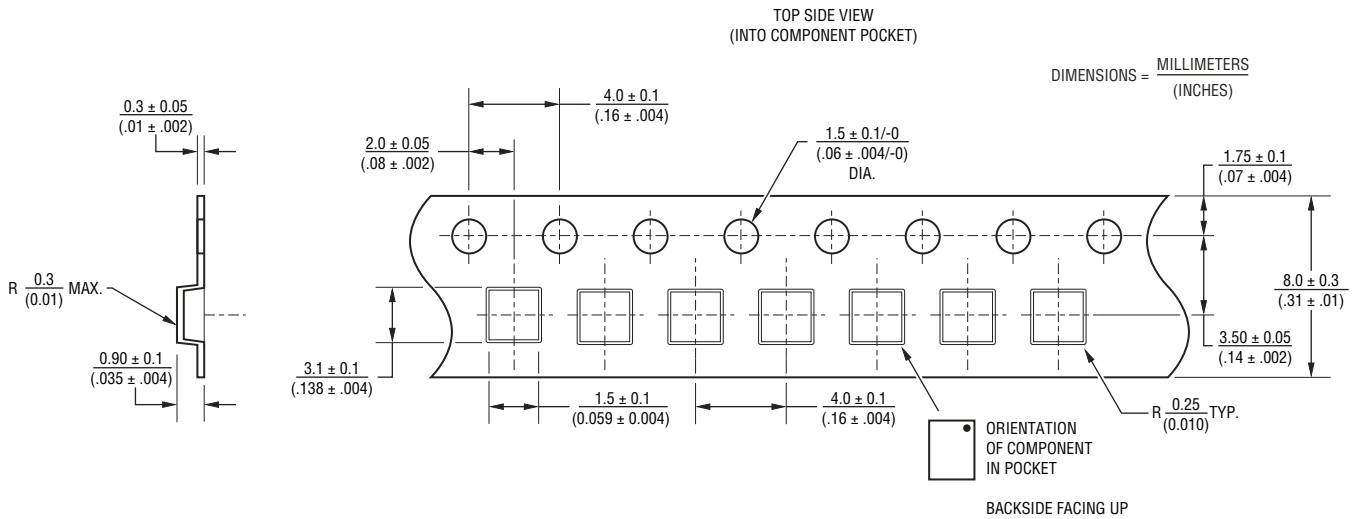

Reliable Electronic Solutions

Asia-Pacific: TEL +886- (0)2 25624117 • FAX +886- (0)2 25624116

Europe: TEL +41-41 768 5555 • FAX +41-41 768 5510

The Americas: TEL +1-951 781-5492 • FAX +1-951 781-5700

www.bourns.com

*RoHS Directive 2002/95/EC Jan 27 2003, including Annex
 Specifications are subject to change without notice.
 Customers should verify actual device performance in their specific applications.

射频和天线设计培训课程推荐

易迪拓培训(www.edatop.com)由数名来自于研发第一线的资深工程师发起成立,致力并专注于微波、射频、天线设计研发人才的培养;我们于 2006 年整合合并微波 EDA 网(www.mweda.com),现已发展成为国内最大的微波射频和天线设计人才培养基地,成功推出多套微波射频以及天线设计经典培训课程和 ADS、HFSS 等专业软件使用培训课程,广受客户好评;并先后与人民邮电出版社、电子工业出版社合作出版了多本专业图书,帮助数万名工程师提升了专业技术能力。客户遍布中兴通讯、研通高频、埃威航电、国人通信等多家国内知名公司,以及台湾工业技术研究院、永业科技、全一电子等多家台湾地区企业。

易迪拓培训推荐课程列表: <http://www.edatop.com/peixun/tuijian/>



射频工程师养成培训课程套装

该套装精选了射频专业基础培训课程、射频仿真设计培训课程和射频电路测量培训课程三个类别共 30 门视频培训课程和 3 本图书教材;旨在引领学员全面学习一个射频工程师需要熟悉、理解和掌握的专业知识和研发设计能力。通过套装的学习,能够让学员完全达到和胜任一个合格的射频工程师的要求...

课程网址: <http://www.edatop.com/peixun/rfe/110.html>

手机天线设计培训视频课程

该套课程全面讲授了当前手机天线相关设计技术,内容涵盖了早期的外置螺旋手机天线设计,最常用的几种手机内置天线类型——如 monopole 天线、PIFA 天线、Loop 天线和 FICA 天线的设计,以及当前高端智能手机中较常用的金属边框和全金属外壳手机天线的设计;通过该套课程的学习,可以帮助您快速、全面、系统地学习、了解和掌握各种类型的手机天线设计,以及天线及其匹配电路的设计和调试...

课程网址: <http://www.edatop.com/peixun/antenna/133.html>



WiFi 和蓝牙天线设计培训课程

该套课程是李明洋老师应邀给惠普 (HP) 公司工程师讲授的 3 天员工内训课程录像,课程内容是李明洋老师十多年工作经验积累和总结,主要讲解了 WiFi 天线设计、HFSS 天线设计软件的使用,匹配电路设计调试、矢量网络分析仪的使用操作、WiFi 射频电路和 PCB Layout 知识,以及 EMC 问题的分析解决思路等内容。对于正在从事射频设计和天线设计领域工作的您,绝对值得拥有和学习! ...

课程网址: <http://www.edatop.com/peixun/antenna/134.html>



CST 学习培训课程套装

该培训套装由易迪拓培训联合微波 EDA 网共同推出,是最全面、系统、专业的 CST 微波工作室培训课程套装,所有课程都由经验丰富的专家授课,视频教学,可以帮助您从零开始,全面系统地学习 CST 微波工作的各项功能及其在微波射频、天线设计等领域的设计应用。且购买该套装,还可超值赠送 3 个月免费学习答疑...

课程网址: <http://www.edatop.com/peixun/cst/24.html>



HFSS 学习培训课程套装

该套课程套装包含了本站全部 HFSS 培训课程,是迄今国内最全面、最专业的 HFSS 培训教程套装,可以帮助您从零开始,全面深入学习 HFSS 的各项功能和在多个方面的工程应用。购买套装,更可超值赠送 3 个月免费学习答疑,随时解答您学习过程中遇到的棘手问题,让您的 HFSS 学习更加轻松顺畅...

课程网址: <http://www.edatop.com/peixun/hfss/11.html>

ADS 学习培训课程套装

该套装是迄今国内最全面、最权威的 ADS 培训教程,共包含 10 门 ADS 学习培训课程。课程是由具有多年 ADS 使用经验的微波射频与通信系统设计领域资深专家讲解,并多结合设计实例,由浅入深、详细而又全面地讲解了 ADS 在微波射频电路设计、通信系统设计和电磁仿真设计方面的内容。能让您在最短的时间内学会使用 ADS,迅速提升个人技术能力,把 ADS 真正应用到实际研发工作中去,成为 ADS 设计专家...

课程网址: <http://www.edatop.com/peixun/ads/13.html>



我们的课程优势:

- ※ 成立于 2004 年,10 多年丰富的行业经验,
- ※ 一直致力并专注于微波射频和天线设计工程师的培养,更了解该行业对人才的要求
- ※ 经验丰富的一线资深工程师讲授,结合实际工程案例,直观、实用、易学

联系我们:

- ※ 易迪拓培训官网: <http://www.edatop.com>
- ※ 微波 EDA 网: <http://www.mweda.com>
- ※ 官方淘宝店: <http://shop36920890.taobao.com>